

REVISION HISTORY

REV	DESCRIPTION	DATE	APPROVED

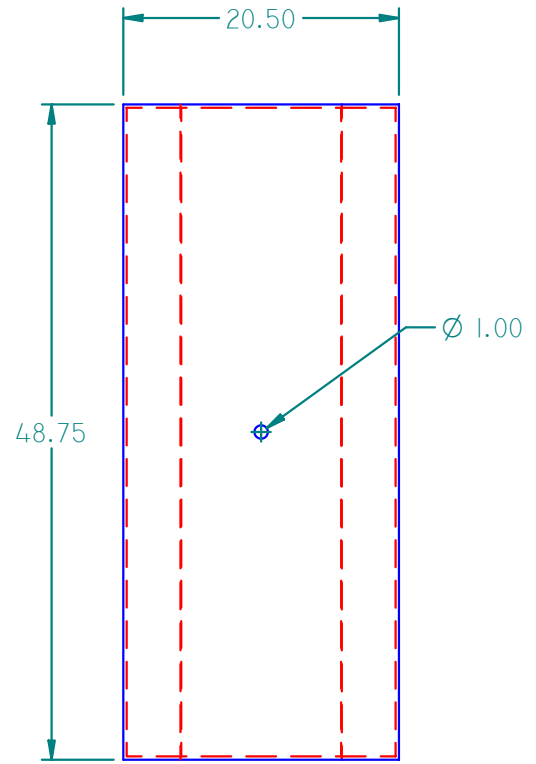

TANKS ARE DESIGNED TO BE USED IN A HORIZONTAL POSITION. RECTANGULAR TANKS USED IN VERTICAL POSITION MAY REQUIRE ADDITIONAL WALL THICKNESS OR EXTERNAL SUPPORT

TANKS ARE NOT RATED FOR GASOLINE OR AROMATIC SOLVENTS

TANK RESINS ARE FULLY UV STABILIZED

MOST SIZE TANKS ARE AVAILABLE IN STANDARD WALL THICKNESS SHOWN OR HEAVY DUTY

ALLOW +/- 1% ON TANK DIMENSIONS FOR OVERALL SIZE VARIANCES

VENT HOLE ON TANK WILL BE WELDED SHUT IF NOT USED FOR FITTING LOCATION

TANK PLASTIC RESIN IS FDA COMPLIANT BASED ON MANUFACTURER'S SPECIFICATIONS

TANKS MEET ABYC AND USCG REQUIREMENTS FOR MARINE WATER AND HOLDING TANK APPLICATIONS

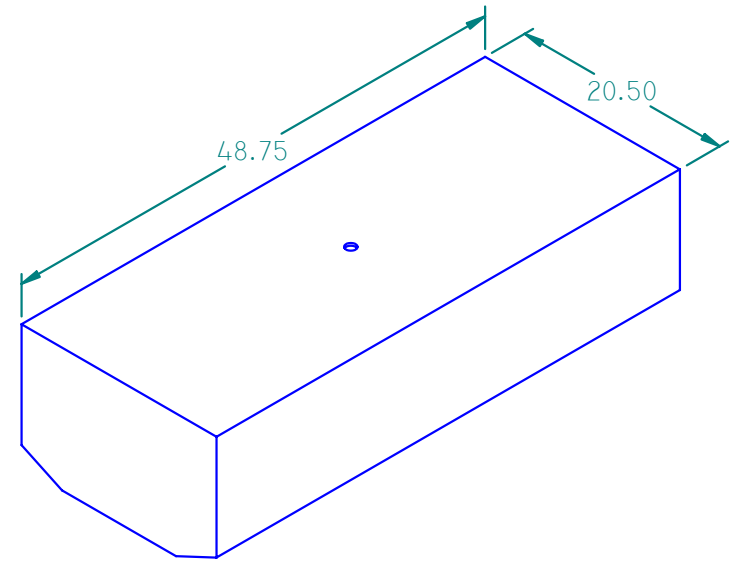

ISO VIEW 120050

